

Cartidge Heater

Material: SS304

OD: 6.25mm-25mm

Ordering: Pls specify product code.

Custom design is also available. Consult factory.

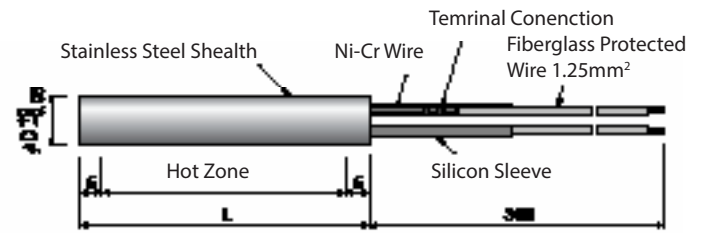
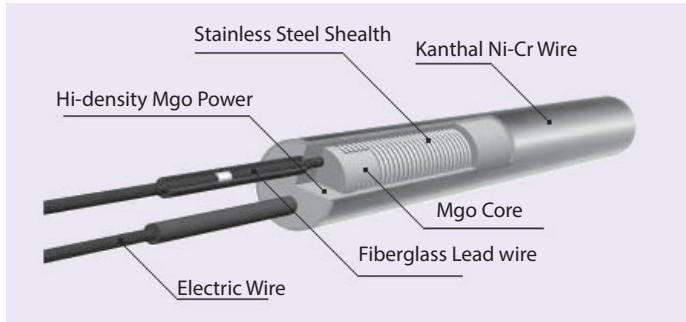

OD: 6.25mm/ 240V

PRODUCT CODE	LENGTH (MM)	WATTS (W)
625510	50	100
625810	90	100
625815	80	150
625110	100	100
625120	100	200

OD: 8.0mm/ 240V

PRODUCT CODE	LENGTH (MM)	WATTS (W)
801540	150	450
801835	180	350
801850	180	500
802040	200	400
802060	200	600
802345	230	450
802365	230	650
802550	250	500
802570	250	700
803055	300	550
803085	300	850

OD: 6.5mm/ 240V

PRODUCT CODE	LENGTH (MM)	WATTS (W)
650510	50	100
650810	80	100
650815	80	150
650110	100	100
650120	100	200

OD: 9.5mm/ 240V

PRODUCT CODE	LENGTH (MM)	WATTS (W)
950510	50	100
950520	50	200
950815	80	150
950825	80	250
951020	100	200
951030	100	300
951320	130	200
951340	130	400
951530	150	300
951550	150	500

OD: 8.0mm/ 240V

PRODUCT CODE	LENGTH (MM)	WATTS (W)
800510	50	100
800815	50	150
800810	80	100
800820	80	200
801015	100	150
801025	100	250
801320	130	200
801330	130	300
801530	150	300

CONT'

OD:10mm/ 240V

PRODUCT CODE	LENGTH (MM)	WATTS (W)
100510	50	100
100520	50	200
100815	80	150
100825	80	250
101020	100	200
101030	100	300
101320	130	200
101340	130	400
101530	150	300
101550	150	500
101840	180	400
101865	180	650
102045	200	450
102070	200	700
102355	230	550
102380	230	800
102560	250	600
102590	250	900
103070	300	700
103010	300	1000

OD:12mm/ 240V

PRODUCT CODE	LENGTH (MM)	WATTS (W)
120510	50	100
120520	50	200
120820	80	200
120830	80	300
121025	100	250
121040	100	400
121330	130	300
121350	130	500
121540	150	400
121560	150	600
121850	180	500
121880	180	800
122055	200	550

OD:12mm/ 240V

PRODUCT CODE	LENGTH (MM)	WATTS (W)
122085	200	850
122370	230	700
122310	230	1000
122570	250	700
122510	250	1050
123085	300	850
123013	300	1300

OD:14mm/ 240V

PRODUCT CODE	LENGTH (MM)	WATTS (W)
140510	50	100
140520	50	200
140820	80	200
140830	80	300
141025	100	250
141045	100	450
141335	130	350
141355	130	550
141540	150	400
141570	150	700
141855	180	550
141890	180	900
142065	200	650
142010	200	1000
142375	230	750
142311	230	1150
142580	250	800
142512	250	1250
143010	300	1000
143015	300	1500

OD: 15.0mm/ 240V

PRODUCT CODE	LENGTH (MM)	WATTS (W)
150515	50	150
150520	50	200
150825	80	250
152840	80	400
151035	100	350
151050	100	500
151345	130	450
151365	130	650
151555	150	550
151580	150	800
151865	180	650
151895	180	950
152070	200	700
152010	200	1050
152385	230	850
152312	230	1250
152590	250	900
152513	250	1350
153010	300	1050
153016	300	1600

OD:16mm/ 240V

PRODUCT CODE	LENGTH (MM)	WATTS (W)
160515	50	150
160525	50	250
160825	80	250
160840	80	400
161035	100	350
161055	100	550
161340	130	400
161370	130	700
161555	150	550
161585	150	850
161865	180	650
161895	180	950
162075	200	750
162011	200	1150
162390	230	900
162313	230	1300
162595	250	950
162514	250	1450
163011	300	1150
163017	300	1750



OD:18mm/ 240V

PRODUCT CODE	LENGTH (MM)	WATTS (W)
180515	50	150
180525	50	250
180830	80	300
180845	80	450
181040	100	400
181060	100	600
181355	130	550
181380	130	800
181560	150	600
181595	150	950
181875	180	750
181811	180	1150
182085	200	850
182013	200	1300
182310	230	1000
182315	230	1500
182510	250	1050
182516	250	1600
183013	300	1300
183019	300	1950

OD:20mm/ 240V

PRODUCT CODE	LENGTH (MM)	WATTS (W)
200520	50	200
200530	50	300
200835	80	350
200850	80	500
201045	100	450
201065	100	650
201360	130	600
201390	130	900
201570	150	700
201510	150	1050
201885	180	850
201812	180	1250
202095	200	950
202014	200	1400
202311	230	1100
202316	230	1650
202512	250	1200
202518	250	1800
203014	300	1450
203022	300	2200



OD: 20.0mm/ 240V

PRODUCT CODE	LENGTH (MM)	WATTS (W)
150515	50	150
150520	50	200
150825	80	250
152840	80	400
151035	100	350
151050	100	500
151345	130	450
151365	130	650
151555	150	550
151580	150	800
151865	180	650
151895	180	950
152070	200	700
152010	200	1050
152385	230	850
152312	230	1250
152590	250	900
152513	250	1350
153010	300	1050
153016	300	1600

ALTERNATIVE TYPE OF CARTRIDGE HEATER WITH BUILT-IN LEAD TERMINATION CONNECTION (BI)

Material: SS304
 OD: 6.25mm-20mm
 PLS USE THE I".
 EXAMPLE: OD:20MM/240V/50MML/150W
 IE.. 150515-BI

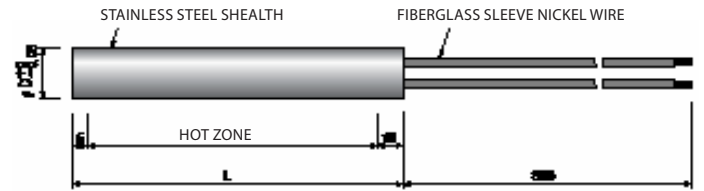

Electric Wire Cross Section Area

DIAMETER OF SHEATH	ELECTRRIC WIRE CROSS SECTION AREA (MM ²)
	0.5
6.5	
8	0.75
9.5	
10	
12	1.25
14	
16	1.5
18	
20	

Lead Wire Type Vs Max Temperature

LEAD WIRES TYPES	MAXIMUM WITHSTAND TEMPERATURE
FIBERGLASS SLEEVE (STANDARD)	300C
TEFLONSLEEVE	280C
SILICA WOOL SLEEVE	400C
CERAMIC BEADS	550C

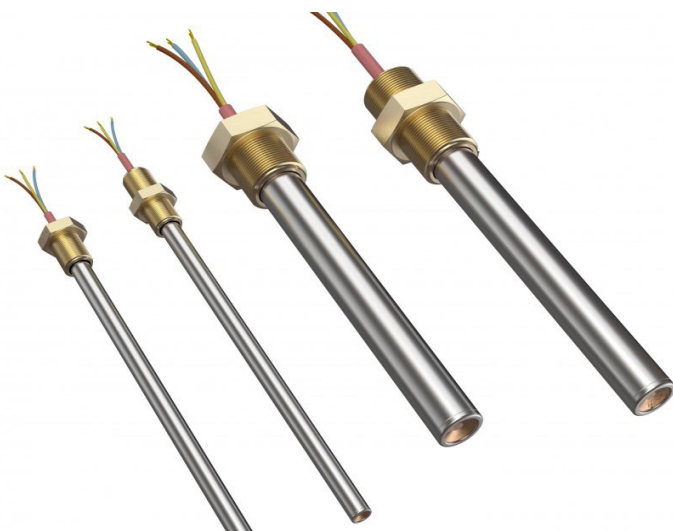

Other option for Cartridge Heater

1) L-Type Cartridge for metal mold.
Terminal is 90 degree. It is good for adaptation in small or restricted space.
Pls indicate (L-Type code when ordering)

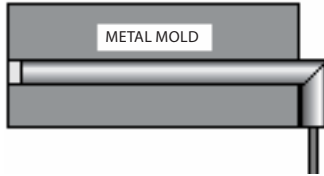

FOR OD:6.5-14mm

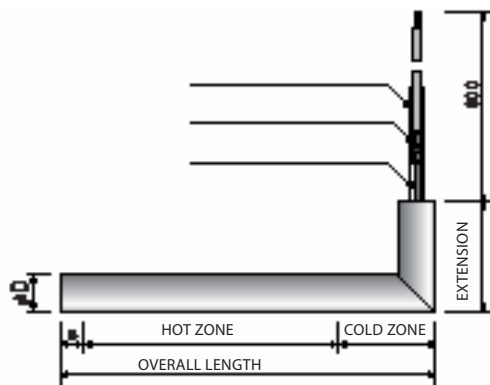

FOR OD:14-20mm

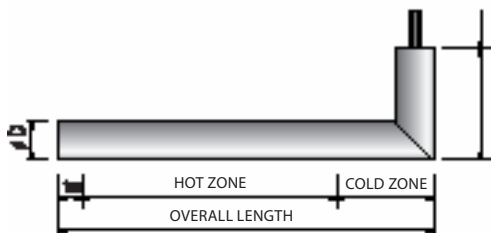

POWER (WATTS)

ALL UNIT HAS A TOLERANCE OF +5%, -10%

RESISTANCE (OHMS):

ALL UNIT HAS TOLERANCE OF +10%, -5%

RESISTANCE INCREASE WITH TEMPERATURE. ALL CARTRIDGES ARE DESIGNED TO A RESISTANCE VALUE 5% LOWER THAN THE CALCULATED RESISTANCE.

2) Flange Type Cartridge for metal mold.
It is good for fixing heater by using a screw.
Pls indicate (Flange type A or B code when ordering)

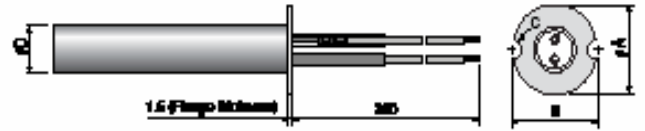

SHEATH DIAMETER (MM)	A	B	C
6.25	18	18	R2.5
6.5			
8			
9.5	24	24	R2.5
10			
12			
14	28	28	R3.0
15			
16			
18	32	32	R3.0
20			

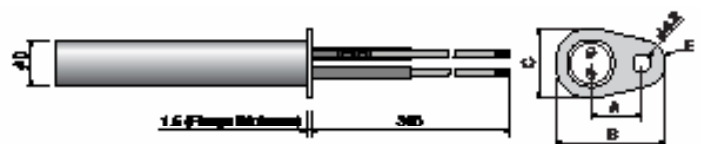

SHEATH DIAMETER (MM)	A	B	C	D
6.25	9	20	14	R4.0
6.5				
8				
9.5	13	28	18	R6.0
10				
12				
14	15	34	24	R7.0
15				
16				
18	15	34	24	R7.0
20				